

These installation instructions are intended for use with the Discharge Pressure Switch (Part No. 437900). Personnel responsible for the system installation, recharge, or maintenance must read and fully understand these instructions before attempting to install or service any discharge pressure switch.

WARNING

The fire suppression system could actuate, introducing a potentially hazardous environment, causing possible serious injury or death if these instructions and precautions are not followed. Always read instructions and follow them carefully during installation.

DESCRIPTION

The discharge pressure switch is operated by agent pressure when the fire suppression system is discharged. The three pole, double throw (3PDT) pressure switch can be used to open or close electrical circuits to shut down equipment (single or 3-phase), turn on lights or alarms, or provide pressure switch feedback to an AUTOPULSE control panel.

The pressure switch specifications are as follows:

Body:	Forged C37700 Brass
Housing:	C.R. Steel, painted red
Pressure Connection:	3/8 in. NPT Female
Actuation Pressure:	Less than 50 psi (3.4 bar)
Max. Working Pressure:	2900 psi (200.0 bar)
Proof Pressure:	8333 psi (574.5 bar)
Temperature Range:	-4 °F to +130 °F (-20 °C to +54 °C)
Dimensions:	4 1/2 in. (L) x 2 5/8 in. (W) x 4 1/2 in. (H) (114 mm (L) x 67 mm (W) x 114 mm (H))
Weight:	2.2 lb (1.0 kg)
IP Rating:	IP65
Switch Configuration:	3PDT
Electrical Ratings:	15A, 125 VAC 10A, 250 VAC 3/4 HP, 250 VAC 1-, 2-, or 3-phase
Electrical Connections:	1/2 in. and 3/4 in. Conduit Knockouts with #6-32 UNC Terminal Screws

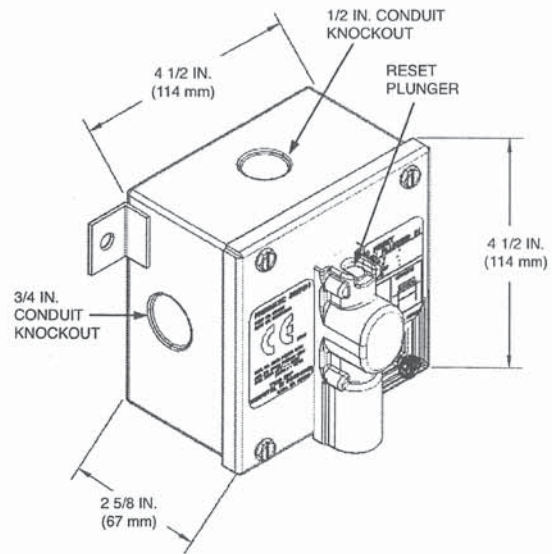

FIGURE 1
008919

INSTALLATION

Mounting the Enclosure

The pressure switch enclosure is designed to be mounted on any suitable flat surface, near the agent storage tanks, using the two mounting tabs provided.

Pressure Port Connection

The switch is designed to be piped directly off the system discharge manifold (see Figure 2), which is the preferred method, or if the system is utilizing an AUTOMAN II-C releasing device, the pressure switch can be piped off the actuation line (see Figure 3). Piping requirements vary from system to system. Consult the system installation manual for specific installation piping requirements for auxiliary pressure-operated devices. A 3/8 in. to 1/4 in. reducing bushing is supplied with the pressure switch assembly to facilitate connection to 1/4 in. actuation hose.

PRESSURE CONNECTION TO SYSTEM DISCHARGE MANIFOLD

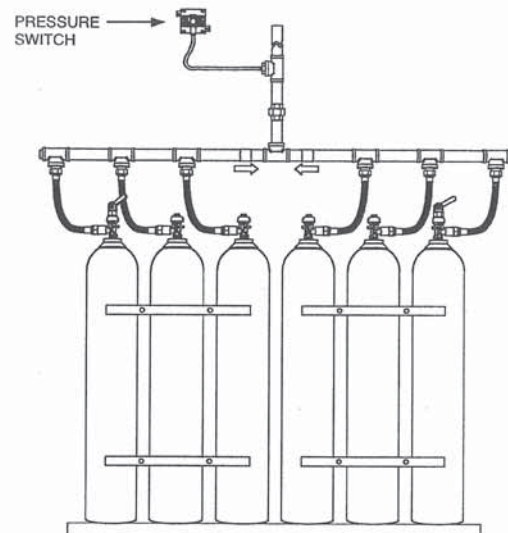

FIGURE 2
008920

**DISCHARGE PRESSURE SWITCH
INSTALLATION INSTRUCTIONS**

INSTALLATION (Continued)

PRESSURE CONNECTION TO AN AUTOMAN II-C RELEASE

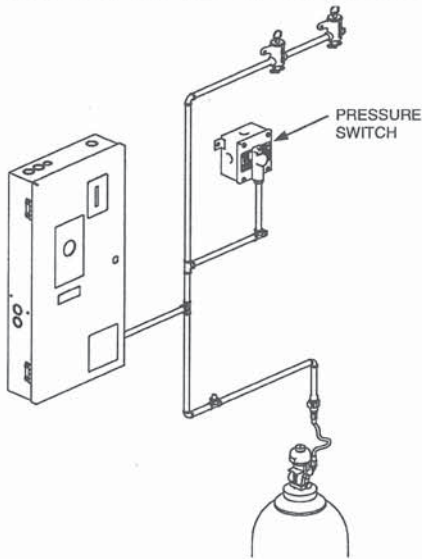

FIGURE 3
006921

WIRING

WARNING

To ensure the pressure switch maintains its listed IP rating, proper conduit seals must be used when connecting the conduit system to the pressure switch enclosure. Failure to do so may result in premature pressure switch failure, resulting in a potentially hazardous condition that may cause serious injury or death.

NOTICE

Power-limited and non-power-limited circuits should not be wired in the same pressure switch. Separate switches should be used if switching of both types of circuits is desired.

The pressure switch can be wired to provide system discharge feedback to an AUTOPULSE control panel, or to directly switch equipment on or off upon system discharge. The contact arrangement of the switch is shown in Figure 4. Contacts are shown with the switch in the "set" position.

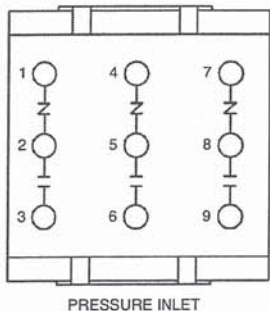

- PRESSURE SWITCH CONTACT ARRANGEMENT**
- 1: Pole 1, Normally-Closed (NC₁)
 - 2: Pole 1, Common (COM₁)
 - 3: Pole 1, Normally-Open (NO₁)
 - 4: Pole 2, Normally-Closed (NC₂)
 - 5: Pole 2, Common (COM₂)
 - 6: Pole 2, Normally-Open (NO₂)
 - 7: Pole 3, Normally-Closed (NC₃)
 - 8: Pole 3, Common (COM₃)
 - 9: Pole 3, Normally-Open (NO₃)

FIGURE 4
006922

Pressure Switch Feedback

For system discharge feedback to a control panel, the switch should be wired as shown in Figure 5.

WIRING FOR PRESSURE SWITCH FEEDBACK

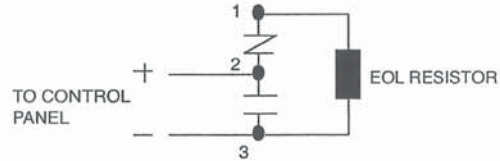

FIGURE 5
006923

Upon system actuation, the normally-closed (N.C.) contacts open and the normally-open (N.O.) contacts close, bypassing the End-Of-Line (EOL) resistor and signaling the panel that a discharge has occurred.

Consult the specific control panel installation and operation manual for proper EOL resistor value.

Direct Equipment Shutdown/Activation

WARNING

Exceeding the switches listed electrical ratings can damage the switch, creating a potentially hazardous situation that may cause serious injury or death. Care should be taken to ensure listed ratings are not exceeded.

For direct equipment shutdown or activation, the switch should be wired as shown in Figures 6 and 7.

WIRING FOR DIRECT EQUIPMENT SHUTDOWN

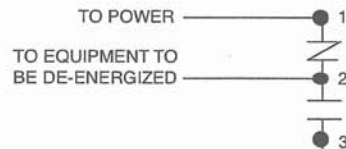

FIGURE 6
006924

WIRING FOR DIRECT EQUIPMENT ACTIVATION



FIGURE 7
006925

NOTICE

A single pressure switch should not be used to switch circuits utilizing different voltages. If equipment utilizing different voltages is being used, separate switches should be used for each voltage level.

WIRING (Continued)

Ground-Fault Protection

To properly ground the switch assembly, two green-colored ground screws are provided, one in the back box and one on the front cover (see Figure 8). Both should be bonded to earth, when required, to ensure the entire assembly is protected against ground-fault short circuits.

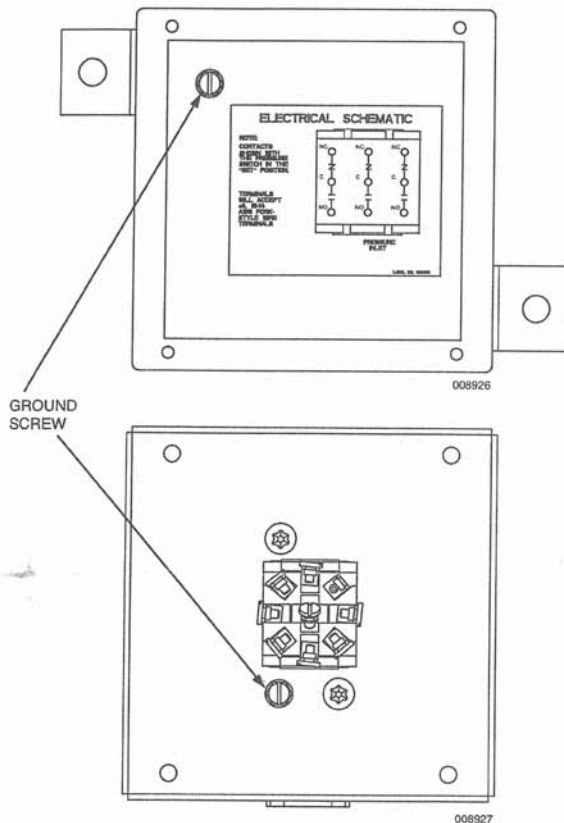

ENCLOSURE GROUND SCREW (ABOVE) AND FRONT COVER GROUND SCREW (BELOW)

FIGURE 8

FUNCTIONAL TEST

⚠ WARNING

Ensure the suppression system is locked out when testing the discharge pressure switch. Failure to do so may result in introducing a potentially hazardous environment causing serious injury or death.

The pressure switch plunger is designed so that, once installed, the switch cover does not have to be removed to test the switch's functionality. To test the switch, perform the following steps:

1. Insert a flat-blade screwdriver or other instrument into the groove on the side of the plunger.
2. Pull up on the plunger until an audible click is heard.
3. The pressure switch contacts will transfer. Verify the switch produced the desired system response.
4. Depress the plunger, returning it to the "set" position, to reset the switch contacts.

RESET AND RECHARGE

To reset the pressure switch after a system discharge, perform the following steps:

1. Remove the pressure from the actuation line of the pressure switch (if not already done).
2. Depress the plunger on top of the switch until the top of the plunger is flush with the top of the pressure port. An audible click should be heard.